



Bathroom Installation Instructions



Cutting Akril Down

Akril is an Australian made environmentally friendly, highly engineered polymer, enhanced with colour. Quite simply, it offers a new source of design inspiration kitchen and sliding doors. Being half the weight of glass and 25 times more impact resistant Akril is the logical alternative providing a safe environment for families knowing Akril will not shatter when hit with force.

Circular Saw

Always cut Akril on a flat secured surface.

With quality equipment, an excellent edge finish can be achieved with Akril. The main factors in achieving the best possible outcome with a circular saw are:

- Panel rigidity. Clamp the sheet on both sides of the cut.
- Saw stability. Always use a good quality fence or guide to improve saw stability and straight-line cutting.
- Saw bearing quality. The price of a circular saw can be a good indication of the quality of the bearings used inside. Cheaper saws often use bushes that offer little to limit the blade's sideways float, and will begin to wear quickly. This will have a dramatic impact on cut quality.
- Blade selection. Always use a blade with the correct cutting geometry. Aluminum blades generally work well with Akril.

Reduce the cutting depth to allow the blade to cut approximately 7mm through the Akril, preferably cutting into a sacrificial MDF board or similar.

Circular Blade Geometry and Conditions

Circular Blades for Akril.

Akril is best cut using fine-tooth Aluminum circular blades with either a "hollow ground" geometry or a "triple chip" blade with the following geometry and conditions;

Blade Diameter	255-305mm
Number of Teeth	80-100
Tooth Thickness	3-3.5mm
Clearance Angle	15-20°
Cutting Angle (Rake)	-5°
Cutting Angle of Setting Band	2-3°
Blade Speed	3000-5000rpm
Surface Speed	3000-4000m/min

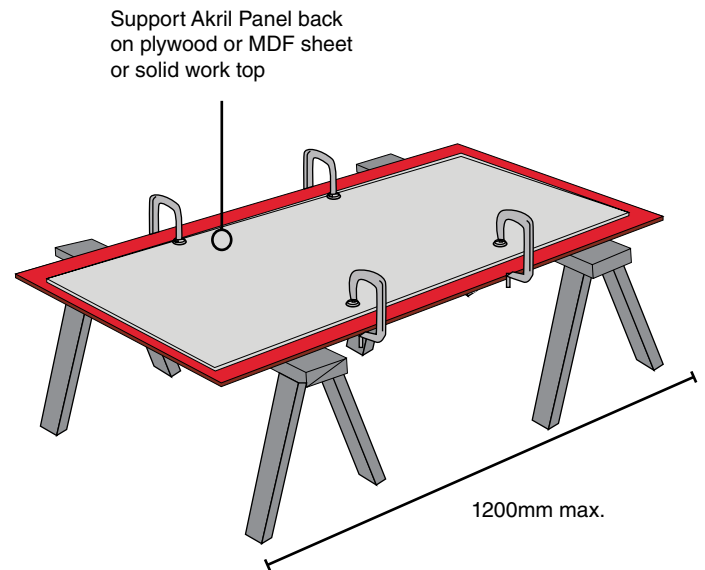

Hole Saws

Hole saws should be sharp, but the pilot drill blunt. It is recommended to drill the hole saw half way through, then turn the Akril over and finish the hole.

This prevents the edge from "blowing out". De-bur the edge with 100-grit sandpaper.

Cutting of Penetrations

When measuring and marking for cut-outs around power outlet boxes etc, ensure enough clearance is given for the switch body and that the cover plates or bulkhead fittings will cover the finished cut-outs.

Use an approved sealer to seal the edge and a 50mm perimeter of the painted side of any Cut Outs.

Drilling Akril with a Blunt Drill Bit

Akril can be drilled using any normal drill bit that is slightly blunt. You can blunt a drill bit by first rubbing the tip with a coarse sand paper.

Alternatively you can use a Sutton Multi Purpose drill bit on a slow speed; being particularly careful to reduce the speed as you pass through the other side of your sheet of Akril.

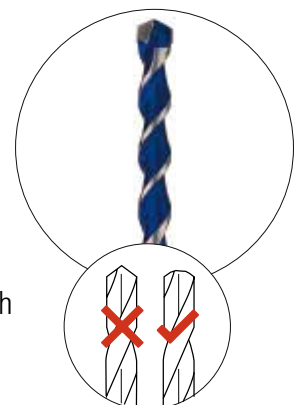

Bathroom Installation

Sealing Edges, Perimeters and Cut Outs

It is important to protect the rear (coated) side of Akril from moisture. Akril needs to be sealed with a band of neutral cure silicon extending 50mm from the edge of the panel.

This should include:

- The perimeter of the sheet including any cut outs made
- Perimeter of any penetrations made i.e. tape holes
- The edges of these cut outs

50MM BAND OF SEALER AROUND PERIMETER AND EDGES OF PENETRATIONS

50MM BAND OF SEALER AROUND PERIMETER

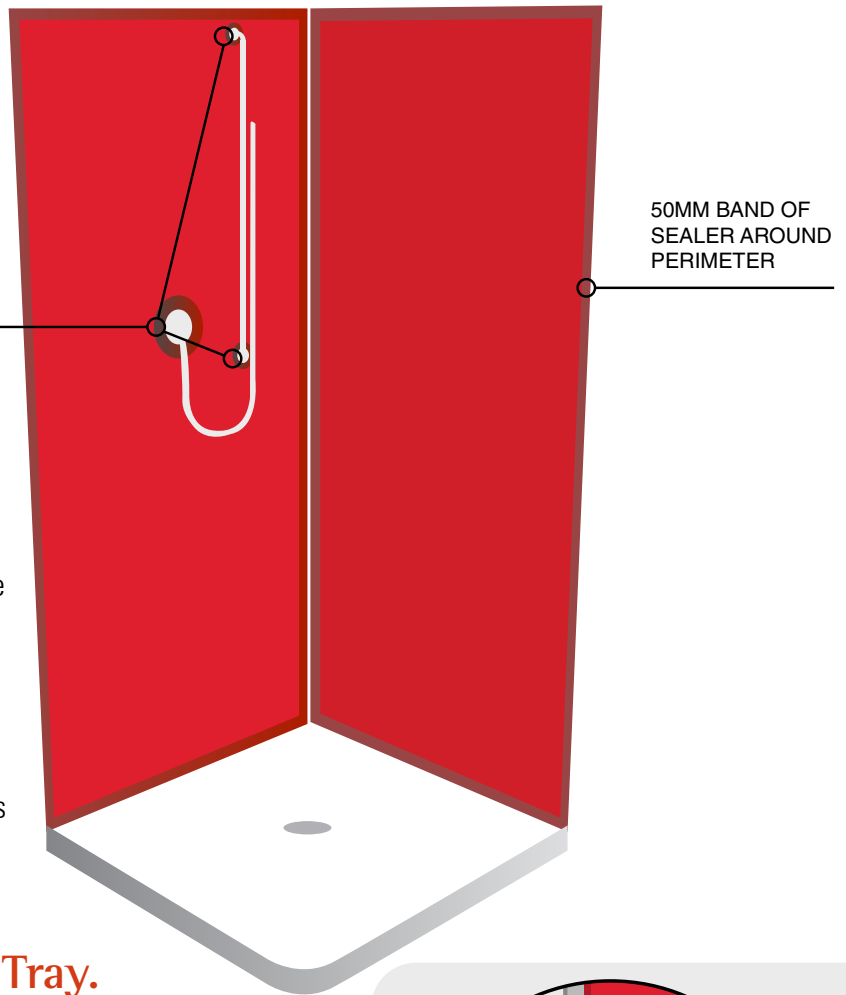

Installing Akril into a Shower Tray.

Acrylic shower trays are commonly installed using the system detailed below.

Acrylic tray should be mounted up to the bottom plate of wall in accordance with the manufacturer's installation instructions.

A manufacturer's recommended water proof board should be laid against framing following manufacturer's instructions, down to within 6mm of shower tray.

Flexible caulking should be installed between top of tray and bottom edge of wall lining in a continuous bead, then smoothed off as illustrated.

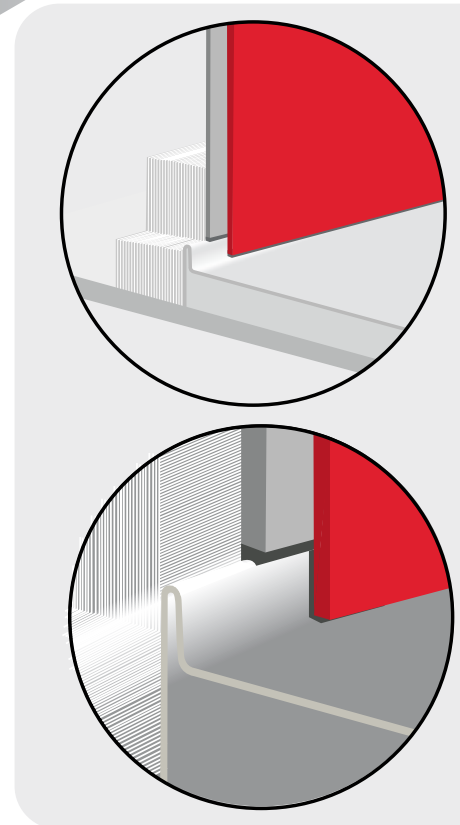
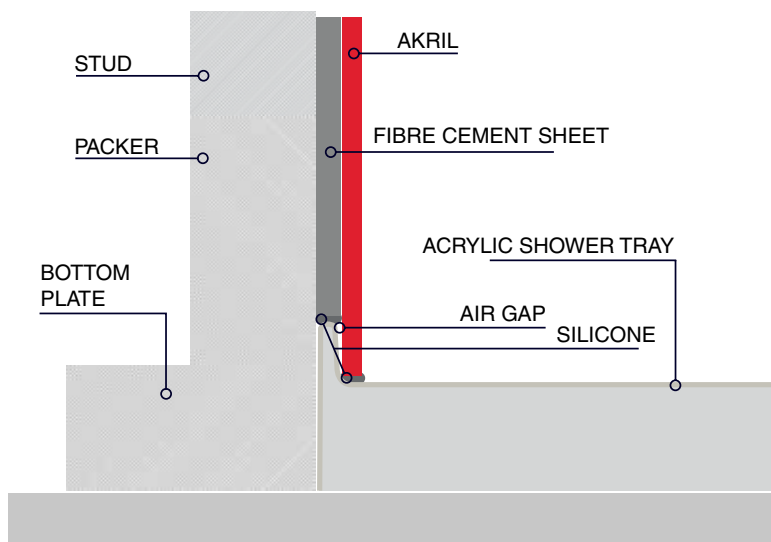

Akril is then installed over the wall lining and over the up-stand lip of the tray, as illustrated above with a bead of flexible caulking between; the back of Akril and front of tray up-stand lip, and the top of tray and bottom edge of Akril.

A gap should be left between the two caulking beads to act as a capillary break.

Note: The waterproofing system for your bathroom or shower must meet specific Australia standard building regulations.

Weep Hole Sealing Detail

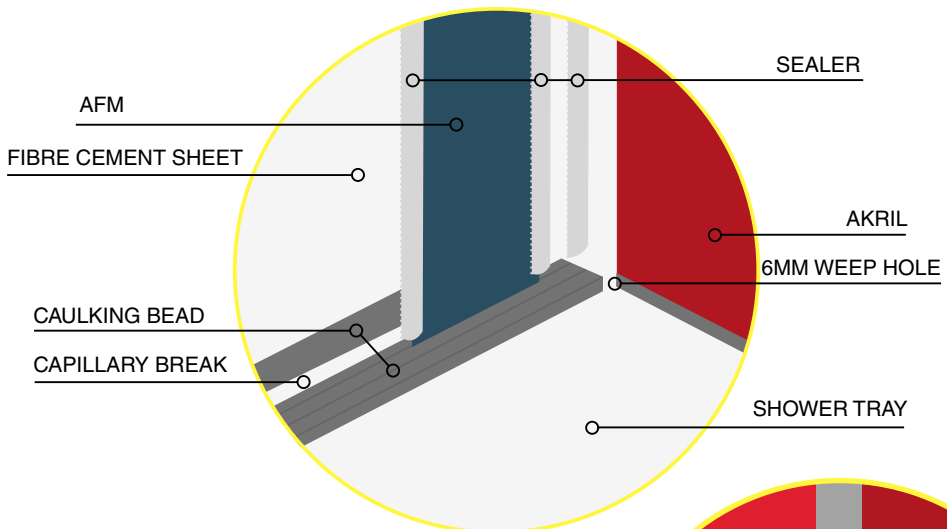

Note: Left side Akрил piece removed to show detail in more clarity.

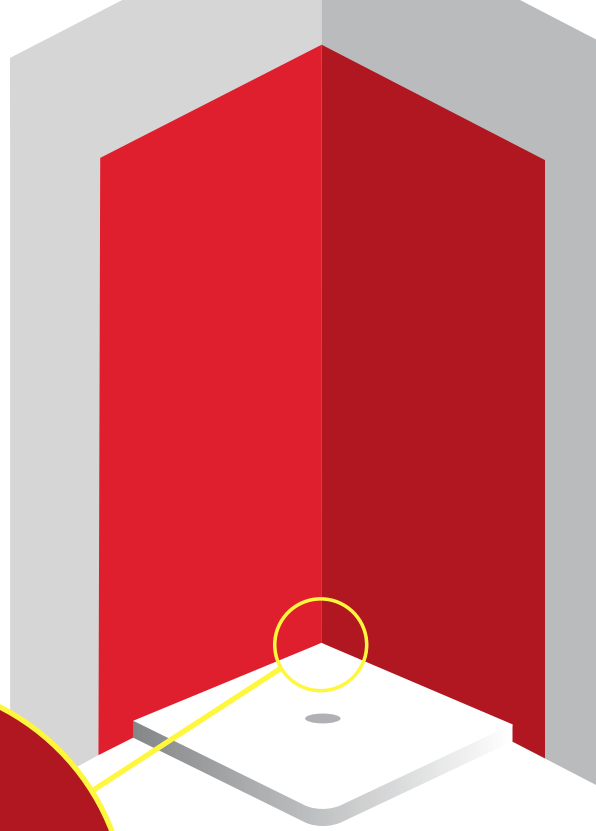
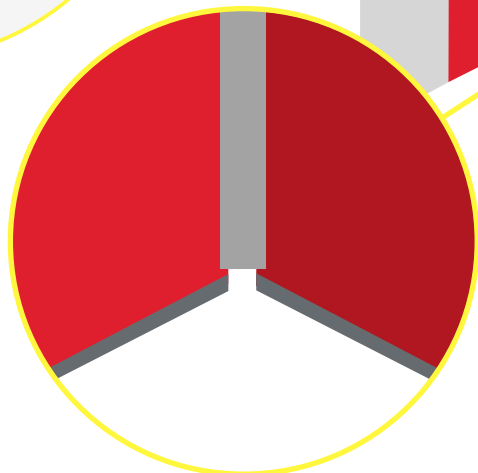

Installing an Anti-Fracture Membrane.

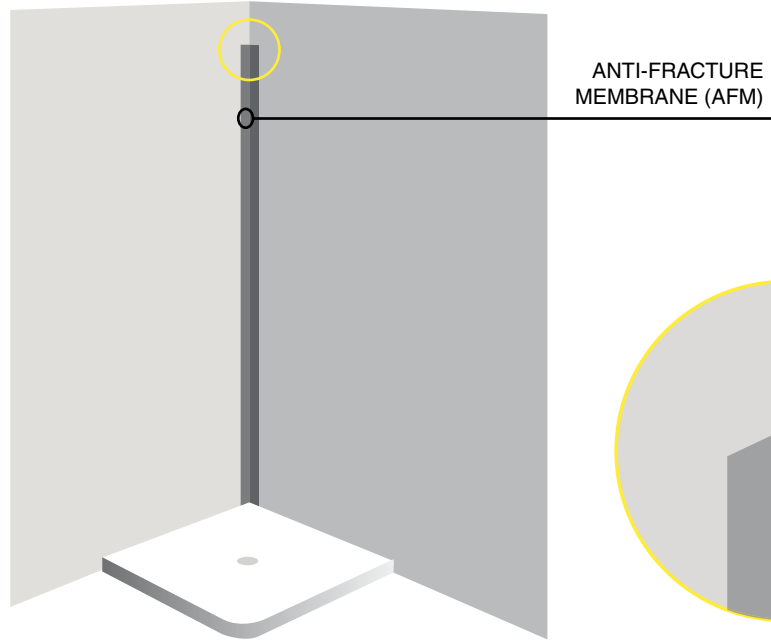

Install a suitable anti-fracture membrane in the internal corner running from the finished installed height of the shower, down and over the lip of the tray, terminating at the bottom of the tray lip. There should be as small a radius as possible in the wall corner.

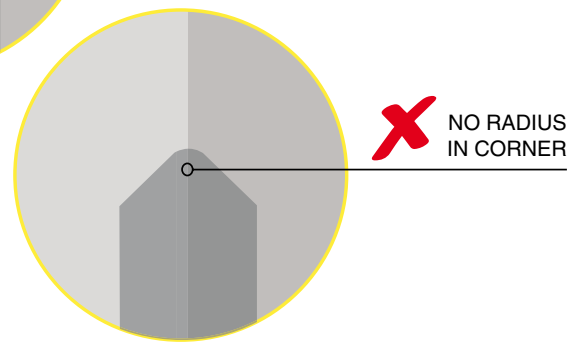
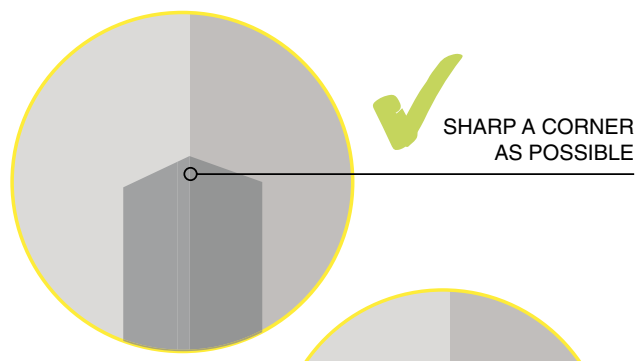

Pre-drilling Screw Holes (shower frame)

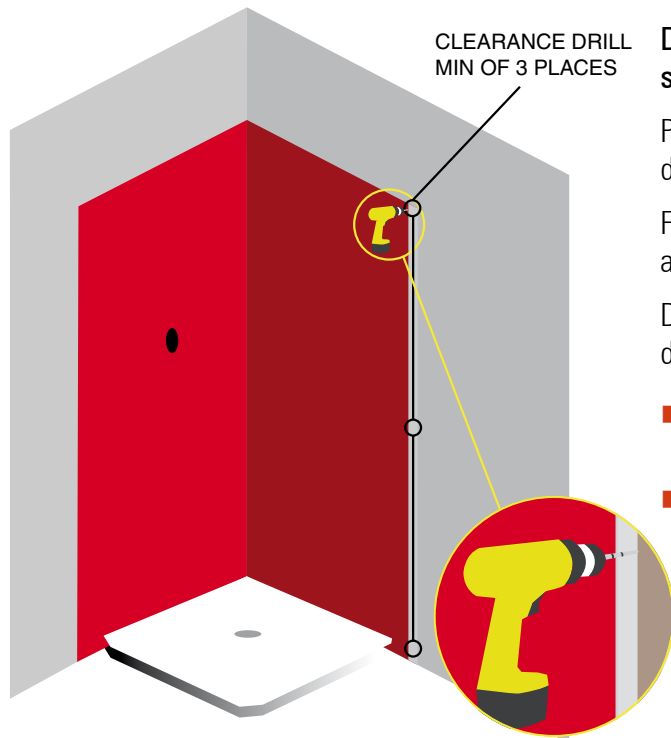

Do Not Screw Directly Into Akril as it may cause the Akril sheet to split.

Peel back protective film from front face of Akril, to the width of door return + 25mm from the outer edge of Akril.

Fit door returns in place ensuring they are in the correct position and plumb.

Drill clearance holes through Akril and wall linings using a blunt drill bit outlined in detail for machining Akril.

- A minimum of 3 fixing points should be used in a 1.8m high shower.
- A minimum of 4 fixing points should be used in a 2m high shower.

Drilling Akril with a Blunt Drill Bit

Akril can be drilled using any normal drill bit that is slightly blunt. You can blunt a drill bit by first rubbing the tip with a coarse sand paper.

Alternatively you can use a Sutton Multi Purpose drill bit on a slow speed; being particularly careful to reduce the speed as you pass through the other side of your sheet of Akril.

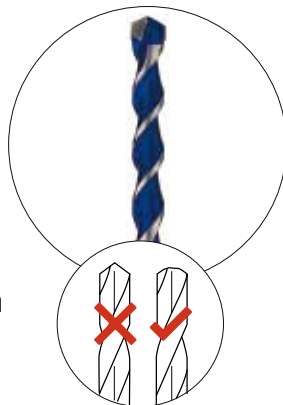

DOOR RETURN

AKRIL

CLEARANCE HOLE FOR SELFTAPPER

FIBRE CEMENT SHEET

FRAMING

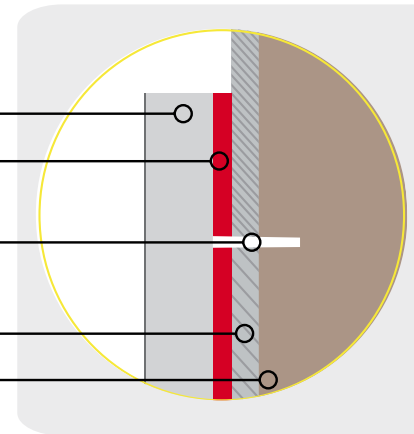

Installing the Internal Corner and Adhere Sheet

- Remove the protective film from rear of Akril.
- Seal the perimeter and all penetrations and penetration edges with a band of neutral cure silicon or acrylic sealant extending 50mm from the edge of the panel as illustrated, above.
- Apply adhesive to rear of Akril as shown in the illustration, above.
- Apply bead of flexible caulking to up-stand lip of tray.
- Apply a bead of flexible caulking along the full height of the corner onto the liner at the edge of the anti-fracture membrane.

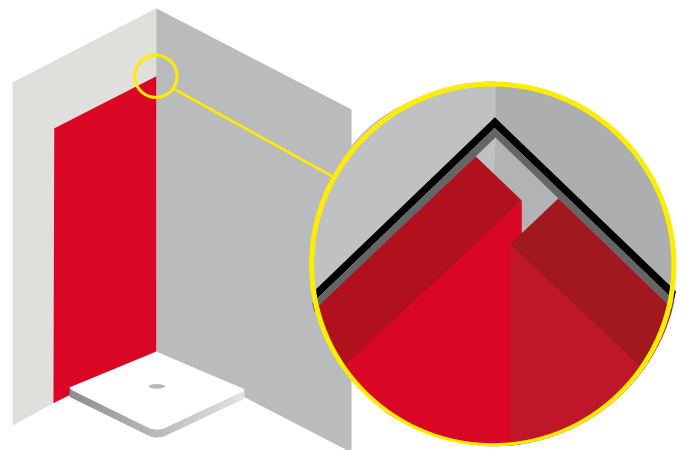

The internal corner is crucial to the installation as it will allow for thermal expansion and contraction.

Applying sealant

Each Akril sheet will expand and contract 3mm into and out of the corner silicone joint.

The first sheet will butt into the wall and allow for 3mm expansion while the second sheet will butt onto the first Akril sheet allowing for expansion and contraction against the first Akril sheet which was installed. This will reduce the visible joint line to 3mm instead of 6mm.

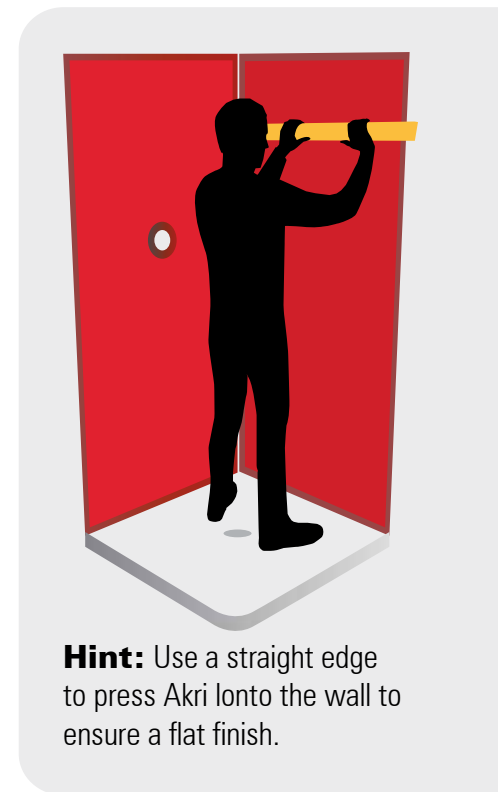
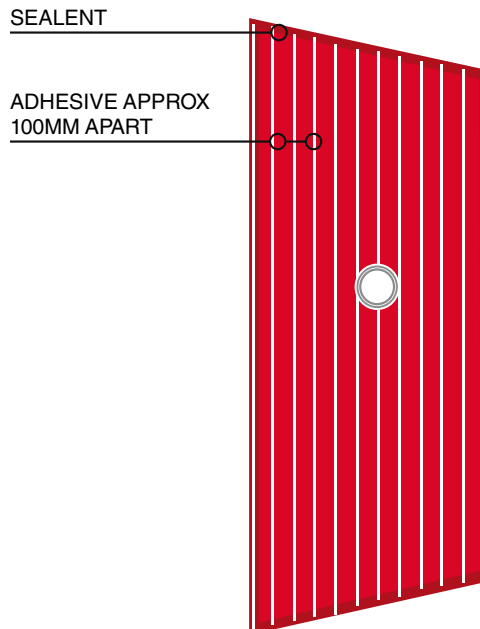

Fixing Shower Frames and Tapes

Tapes

- Peel back protective film from front face of Akril, to 25mm beyond the outer edge of the tapes installed perimeter.
- Apply a bead of flexible caulking around the perimeter and a second bead around the cut out in Akril.
- Both beads should be finished as shown above to allow for any moisture to drain away.
- Fix tapes as per manufacturer's instructions.

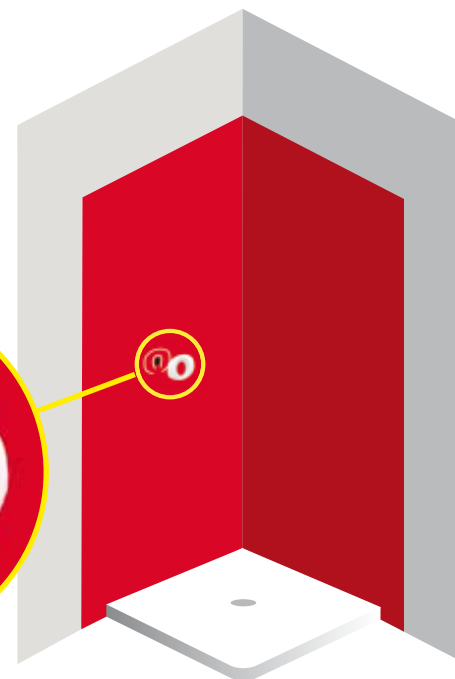

Shower Frames

- Fit door returns back in place.
- Fill holes with flexible caulking before screwing returns to the wall.
- Check for plumb and position before final tightening of door return fastenings.

DOOR RETURN
 AKRIL
 SCREWS BITES INTO FRAME ONLY
 FIBRE CEMENT SHEET
 FRAMING

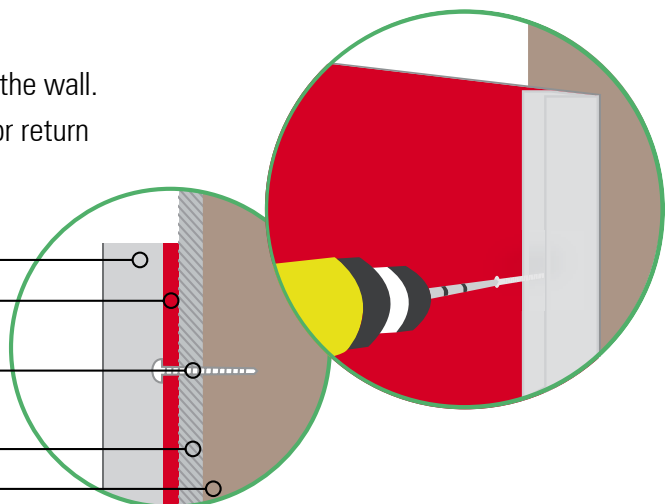

Sealing the Internal Corner

Akril suggest in accordance with water proofing standards a neutral cure silicone bead is run from the top of the Akрил down the internal corner to the bottom of the shower base to seal the panel. This is to prevent any moisture penetrating down behind the lining.

Special attention should be paid to the top and bottom of the internal corner and anti-fracture membrane areas.



Note: Run Silicone down internal corner for water proofing

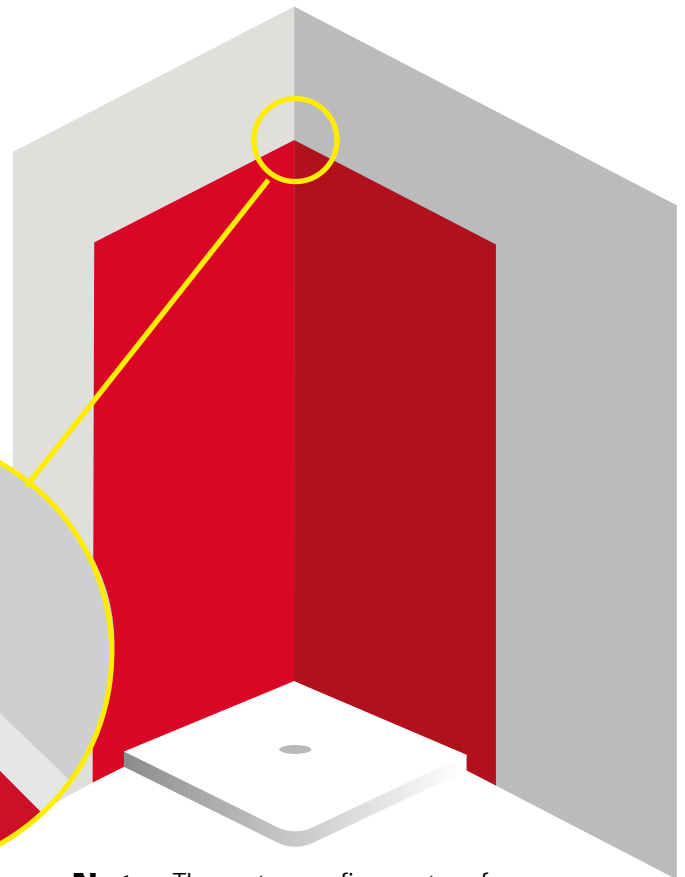

Note: The waterproofing system for your bathroom or shower must meet specific Australia standard building regulations.

Fitting the Showerscreen and Utilities

Fit the Showerscreen to manufactures specification.

If the installer is required to fit any extra utilities to the the Akрил be sure to follow the steps in this document where machining is needed.

This document is a guideline for installing

Akril and will not wear any liability for waterproofing which should be installed to the current Australian Standard.

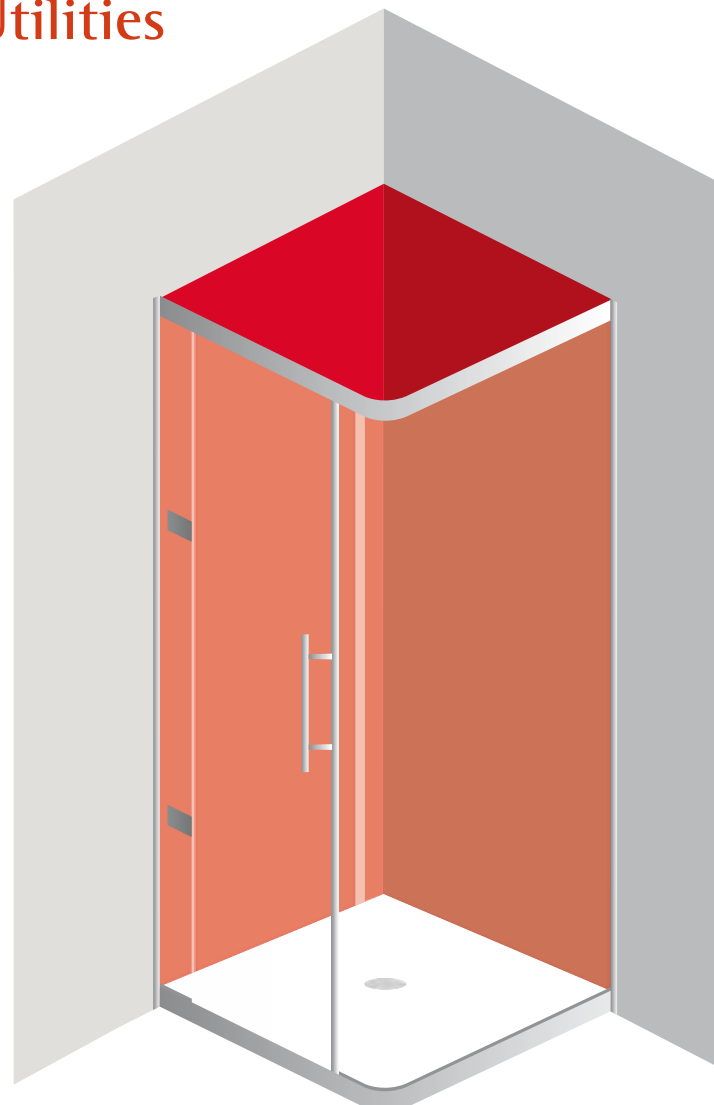

Silicone Spacing and Adhering Sheet



- Remove the protective film from rear of Akрил.
- Seal the perimeter and all penetrations and penetration edges with a band of neutral cure silicon or acrylic sealant extending 50mm from the edge of the panel as illustrated, above.
- Apply adhesive to rear of Akрил as shown in the illustration, above.
- Apply bead of flexible caulking to up-stand lip of tray.
- Apply a bead of flexible caulking along the full height of the corner onto the liner at the edge of the anti-fracture membrane.

The internal corner is crucial to the installation as it will allow for thermal expansion and contraction.

Each Akрил sheet will expand and contract 3mm into and out of the corner silicone joint.

The first sheet will butt into the wall and allow for 3mm expansion while the second sheet will butt onto the first Akрил sheet allowing for expansion and contraction against the first Akрил sheet which was installed. This will reduce the visible join line to 3mm instead of 6mm.

Butting More Than 2 Sheets Together

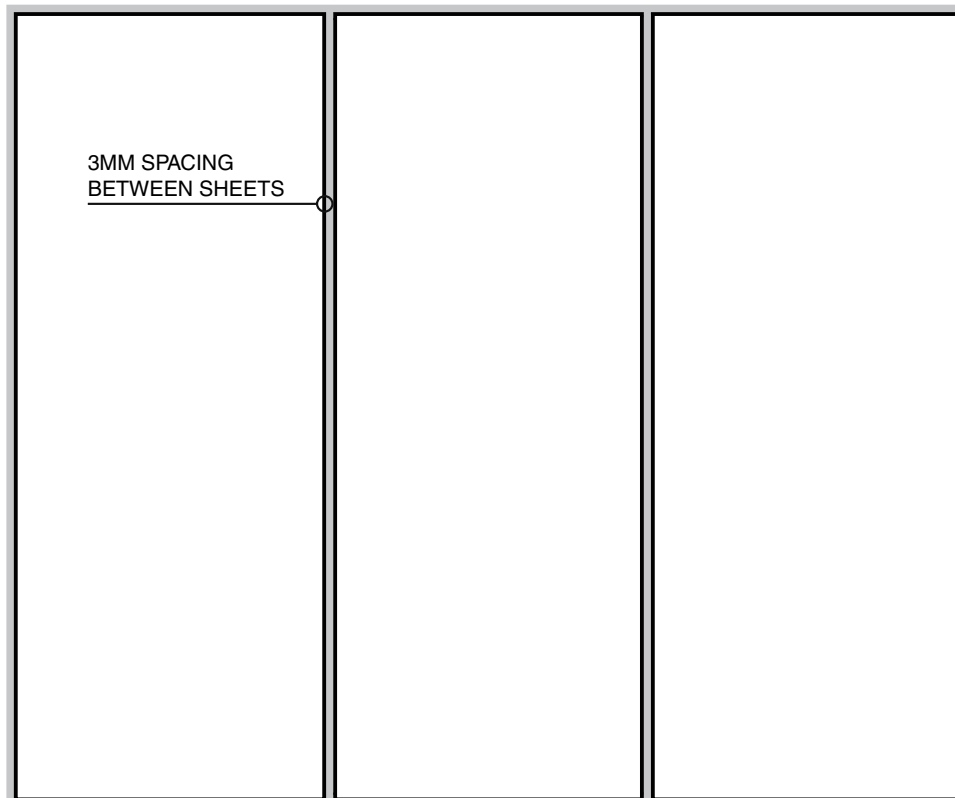

- Measure and cut Akрил Panel to size and geometry required. De-bur all edges
- Remove protective film from the rear of panel.
- Apply adhesive to specification
- Install leading edge allowing 3mm expansion ?
- Roll panel over the wall, smoothing out the sheet in the direction of installation
- Ensure panel is a good fit onto the wall
- Clean up any adhesive that spills out onto the wall

Installing Internal and External Corners

- Remove backing paper.
- Ensure there is an expansion gap of 3mm.
- Apply silicone to the perimeter of the panel to seal the panel to silicone specification Page:
- Press the face of the panel with a straight edge for surface adhesion with wall.

The internal and external corners are crucial to the installation as it will allow for thermal expansion and contraction.

Each Akril sheet will expand and contract 3mm into and out of the corner silicone joint.

The first sheet will butt into the wall and allow for 3mm expansion while the second sheet will butt onto the first Akril sheet allowing for expansion and contraction against the first Akril sheet which was installed. This will reduce the visible joint line to 3mm instead of 6mm.



3MM EXPANSION GAP

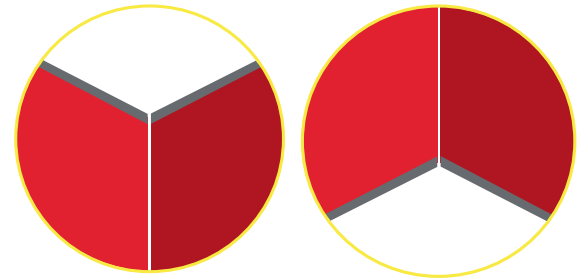

Removing Protective Film

Akril is supplied with protective film on both sides:

Recycled Sticker: Akril is also supplied with a recycled sticker number 7, which should be left on the Akril for its recycled life after use.

Painted Side: has a plastic film design for protection of the painted surface. Remove this film when all machining operations are complete and the panel is ready to be adhered to the wall/surface.

Exposed Side: has a clear plastic film designed for protection against scratches.

Remove the film completely at the very last stage by gently peeling down the sheet surface – never peel at right angles to the sheet as this may pull the sheet away from the installed wall/surface.

Never attempt to cut the protective films with a knife as this may scratch the surface.

Finishing the edge after cutting

If the Akril edge is to be left exposed, it can be easily finished to a polished glass-like quality. A good finish left from the machining process will take considerably less time to finish.

Always peel back the protective film 25mm from the edge while polishing. Remove any sanding dust between grades and polishing compounds immediately.

HAND FINISHING

1. Use a 400-grit paper to remove any cutter marks from the machined edge and then progress to a 600-grit.
2. Chamfer any burrs or marks from the corners.
3. Using a soft, clean cloth and a suitable polishing compound, hand rub the edge to a polished finish.

FLAME POLISHING

A well-machined edge can be flame polished using a Hydrogen/Oxygen mix.

Contact an Acrylic fabricator for this service. An experienced operator can leave an excellent finish.

Warnings

- Akril is not to be used in direct contact with any heat source above 80°C.
- Akril panels are not suitable as a wall finish behind gas cooktops. They can be used as a splashback behind electric and induction cooktops with a minimum clearance of 50mm between rear edge of cook top and the face of the Akril panel.

Technical Support

It is not practical to describe every possible application for Akril in this document.

This document is a guideline for installing Akril and will not wear any liability for waterproofing which should be installed to the current Australian Standard.

For technical help please contact Akril on 1800 464 728.